

VOORBEREIDING

De headset layout

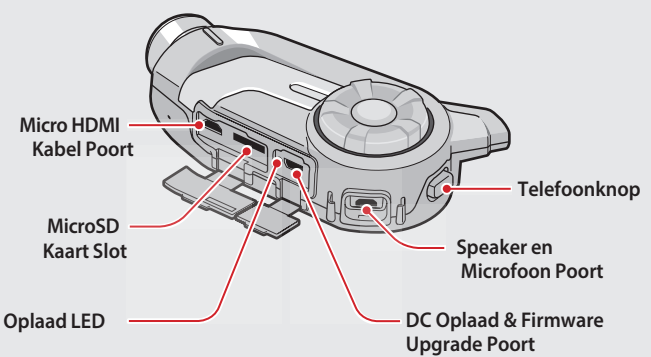

De headset installeren

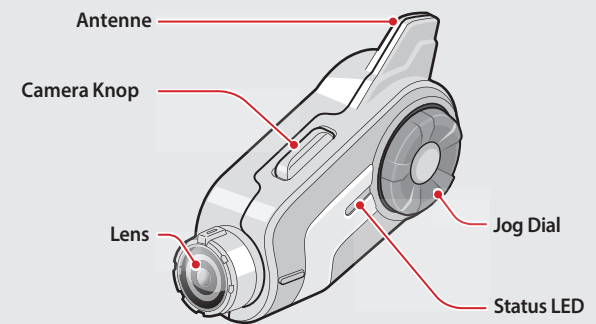
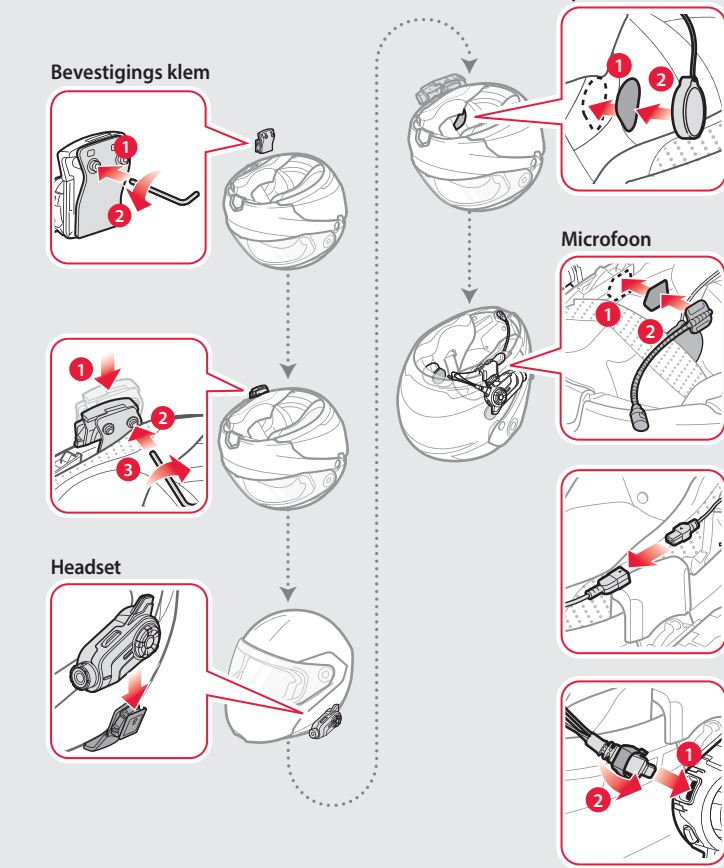

Basiswerking

Knoppen bedienen

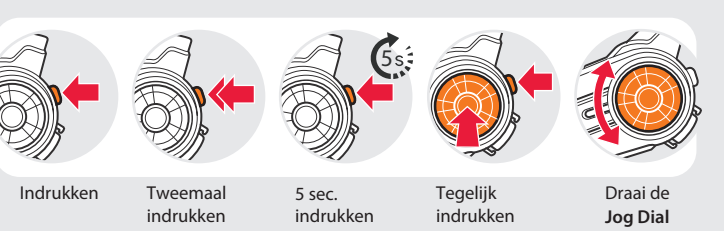

Headset aan/uitschakelen

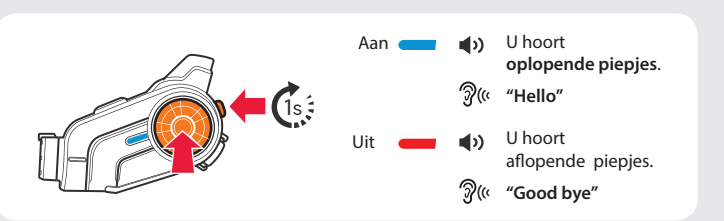

Volume aanpassen



Batterij status

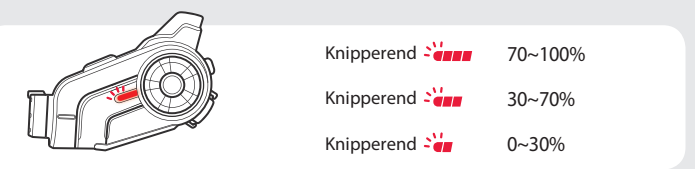

Zet de headset aan en controleer het niveau van de batterij via de status-LED.

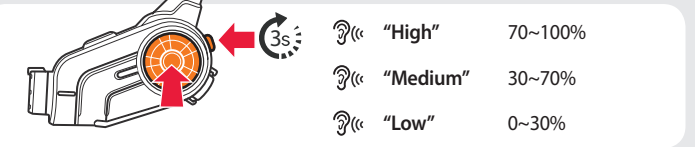

Of houd de Jog Dial en de Telefoon knop voor 3 seconden ingedrukt wanneer de headset wordt ingeschakeld. U zult een drievoudige pieptoon en een gesproken tekst te horen.

Batterij opladen

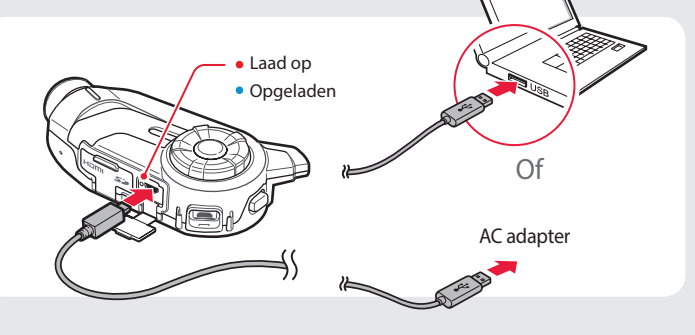

PAIRING

Pairing mobiel apparaat - Telefoon, Muziek

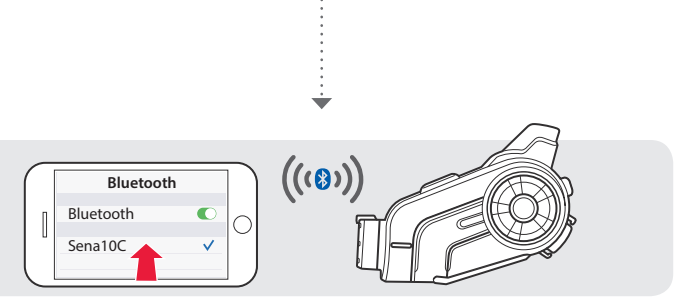
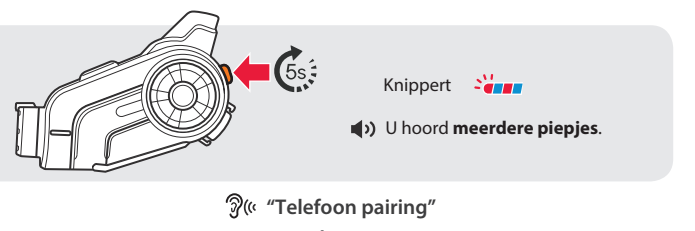

Gebruik telefoon



Gesprekken wisselen tussen een mobiele telefoon en de headset

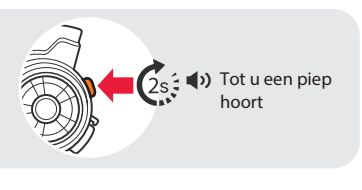

Telefoneren

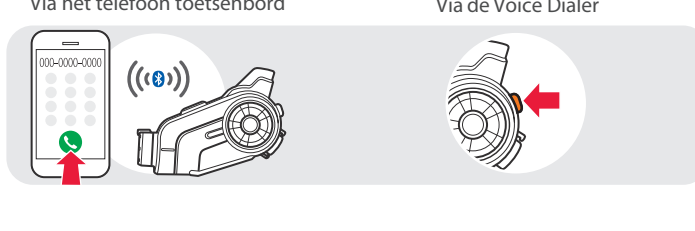

Via de Speed Dial



- U hoort een piep.
- "Speed dial"
- Voice Menu
 - Bel het laatst gebruikte nummer (Redail)
 - Speed dial 1
 - Speed dial 2
 - Speed dial 3
 - Cancel

Muziek luisteren



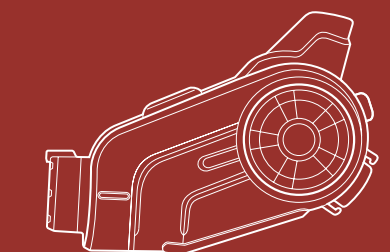

INTERCOM

Pairen met andere Headsets

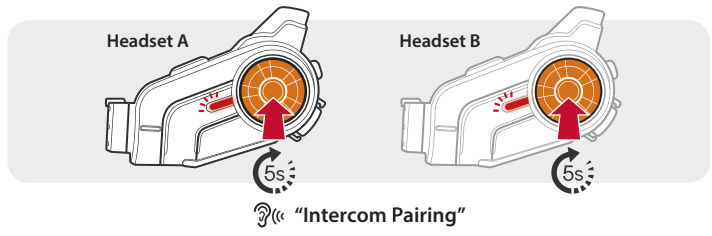

Intercom gebruiken

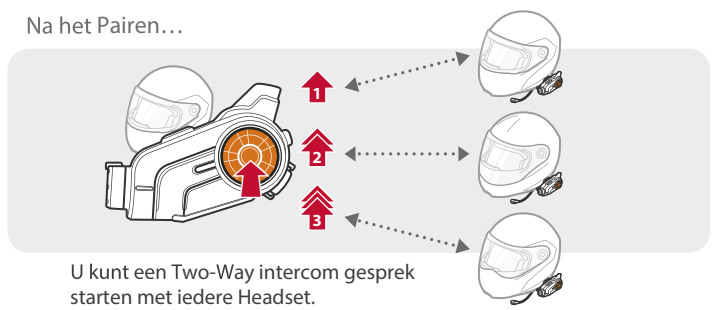

CAMERA

De Camera aan/uit schakelen

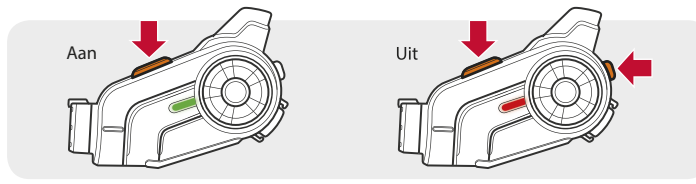

Videos opnemen

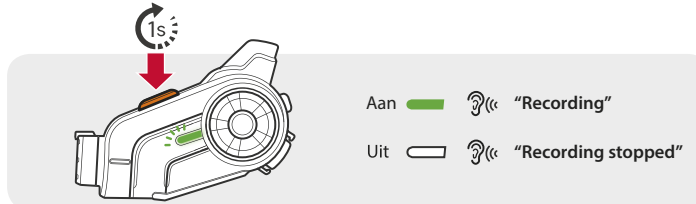

Foto's nemen



Video Tagging

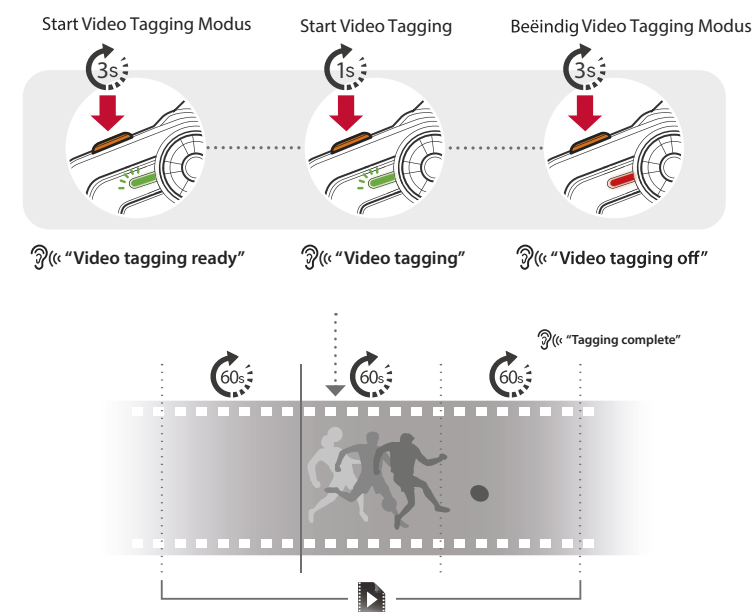

FM RADIO

FM Radio aan/uit zetten

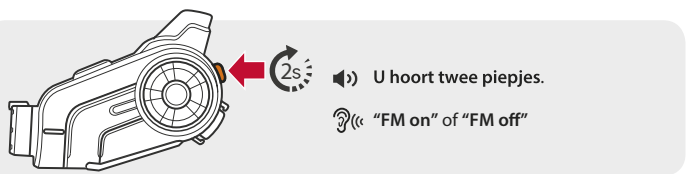

Zoek Stations



Opslaan of Verwijderen van Stations

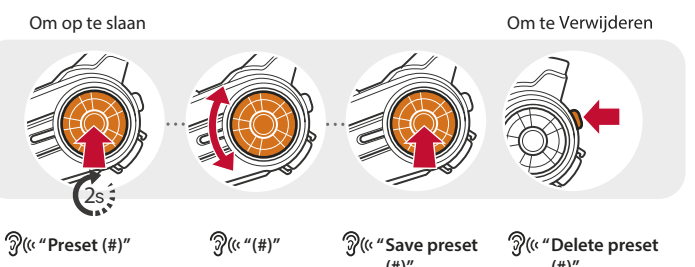

VOORKEUREN

Methode1) Met de headset

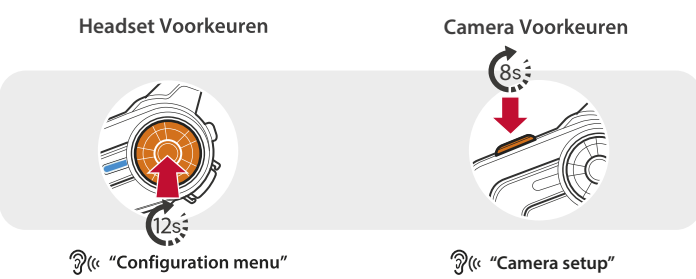

Methode2) Met de Sena Device Manager

Sluit de headset aan op uw computer met een USB-kabel. Start het programma Sena Device Manager en klik op DEVICE SETTING om de headset te configureren.

Voor meer informatie over het downloaden van de Sena Device Manager, verwijzen we u naar de bijsluiters in de verpakking.

Methode3) Met de Sena Smartphone App

- Download op uw smartphone de Sena Smartphone App voor Android of iPhone via Google Play of App Store.
- Raadpleeg www.sena.com/app voor meer informatie.
- Pair uw Smartphone met de headset.
- Start de Sena Smartphone App. Veeg het scherm naar rechts en tik op CONFIGURE om de headset te configureren.

PROBLEEMOPLOSSING

Fabrieksreset

Om de 10C terug te zetten naar de fabrieksinstellingen, houd de telefoon knop voor 12 seconden ingedrukt en druk vervolgens de Jog Dial in. De headset herstelt automatisch de standaardinstelling en wordt uitgeschakeld.

Reset

Als de 10C om een bepaalde reden niet goed werkt, druk dan de Pin-Hole Resetknop aan de achterkant van de headset in.

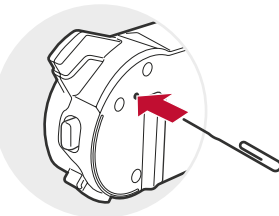

Hoco Parts B.V. Harselaarseweg 104
3771 MB Barneveld The Netherlands www.hocoparts.nl
T: +31 (0)342 - 412290 F: +31 (0)342 - 491749